

See discussions, stats, and author profiles for this publication at: <https://www.researchgate.net/publication/230238183>

Studies on a stove for powdery biomass

Article in *International Journal of Energy Research* · June 1993

Impact Factor: 2.42 · DOI: 10.1002/er.4440170405

CITATIONS

15

READS

49

4 authors, including:



Hanasoge Mukunda

Indian Institute of Science

112 PUBLICATIONS 1,240 CITATIONS

SEE PROFILE



Dasappa S.

Indian Institute of Science

114 PUBLICATIONS 920 CITATIONS

SEE PROFILE



U. Shrinivasa

Indian Institute of Science

50 PUBLICATIONS 354 CITATIONS

SEE PROFILE

STUDIES ON A STOVE FOR POWDERY BIOMASS

H. S. MUKUNDA, S. DASAPPA, B. SWATI AND U. SHRINIVASA

Department of Aerospace Engineering and ASTRA, Indian Institute of Science, Bangalore 560012, India

SUMMARY

The sawdust stove, classically known for several decades, is considered here in a scientific study. The poor ignition characteristics and smoky start up are related to improper geometric dimensions. Based on a parametric study, the start-up procedure and the dimensions of the stove were modified to achieve a smooth start up. Also, the range of acceptable fuels was enlarged to include tiny unprocessed dry twigs, weeds and wood sticks to the extent of about 50%, with the rest being sawdust-like material. The efficiency of the stove was measured to be 30-40%, depending on the relative size and shape of the vessel and the power level of the stove. A simple procedure for designing this class of stove for various power levels, as well as burning times, is presented. A new concept of multiport design is also discussed.

KEY WORDS Stove Powdery biomass Sawdust stove Stoves for rural industry

INTRODUCTION

The need for efficient wood and biomass stoves has been felt strongly the world over for the last five decades. This necessity is felt more intensely in the third world, where the coupling between the pressure of the population and the denudation of forest wealth has occurred to a much larger degree than in the developed countries. Although wood stoves have received an extraordinary amount of attention, stoves for burning powdery biomass have been explored very little. A particularly important point to note is that residues from the felling of trees, leaf droppings from trees, or many agricultural residues contain a large fraction of material close to powder. The use of a low-power grinding machine can be conceived to produce powders of less than 2 mm, so that most of such biomass could be brought into the same form. Classically, the European method of using such biomass is to compact it or briquette it [1]. There are machines that have been built for briquetting biomass [1]. The energy required for this purpose is by no means small. In relatively smaller communities, and where centralised collection is expensive, it appears better to use the biomass in a form close to its natural state for combustion or gasification. The present paper is concerned with the use of biomass for combustion, cooking stoves or combustors for industrial requirements.

A certain stove design seemed to be prevalent in several parts of India, and perhaps in other countries [2] as well, for over several decades. It consisted in using any cylindrical metal box, perhaps the container of a consumer product or any other reject, and creating a fuel geometry, usually with sawdust, as shown in Figure 1. The central hollow region has a diameter, also termed the port diameter, d_p , and the connecting horizontal leg has a diameter d_{ph} . Usually, $d_p = d_{ph}$. Some of the stoves had only a vertical port, right from the bottom to the top, without any horizontal portion. In the preliminary studies aimed at evaluating the effect of various parameters, d_{ph} was varied. These tests were required to assess the performance of the existing stove design in the general usage pattern. The use of any cylindrically shaped object would facilitate tamping and the production of the vertical and horizontal sections of the port. Lighting the stove would be performed by introducing tiny sticks of wood ignited by a match stick (also facilitated by some kerosene at the bottom region of the port). The inner core would burn in the central region. In the early stages, the amount of air drawn by free convection would not be large, as the thermal profile would need to be established. The amount of volatiles released would be dependent on the diameter, the length of the bottom lateral hole, and the height of the central port. Since the draft would be insufficient during the initial stage, the air/fuel ratio would be highly fuel rich, resulting in heavy smoking in the early stages. The period up to which the smoking

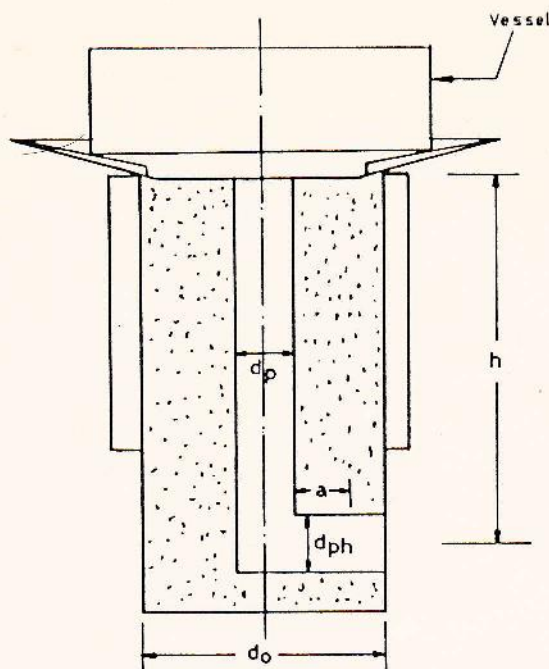

Figure 1. Typical powdery biomass stove with leading dimensions shown: d_p = port diameter; d_{ph} = port diameter on horizontal leg, usually equal to d_p ; d_o = outer diameter of fuel block; h = height of fuel block, a = exposed part of horizontal leg

lasted depended on the actual geometric parameters alluded to above. After this period, the combustion apparently seemed good, with a flame at the top. Measurement of the water boiling efficiency (to be described later) on one such stove gave about 15%. A survey disclosed that these stoves were predominantly used in regions where sawdust was available.

Thus it appeared that (i) the technical problems of smoking in the initial stage must be overcome, (ii) improvements in the efficiency to a level equal to those of single-pan wood stoves should be attempted, (iii) the range of biomass should be extended beyond sawdust, perhaps to include, in part, tiny dry plants, or larger-sized biomass, directly. These aspects are investigated in the present work.

SPECIFICATIONS OF STOVE

The present authors have had earlier experience in the development and dissemination of high-efficiency single-pan wood stoves [3]. Based on this experience, the following requirements for a cooking stove for a family of five or six were drawn up:

- (a) a constant power of 4 kW for about an hour and a half
- (b) as high an efficiency as possible
- (c) very little smoke or soot
- (d) ease of ignition
- (e) portability and ease of use with different vessels and shapes.

The two independent parameters are the burn time t_b and the power level P . In addition to applications to the needs of a kitchen, it was decided to generate designs based on these two parameters for industrial and other applications, depending on the needs.

EXPERIMENTS

Although several early ideas of making hollow, cylindrical blocks using sawdust, with such binders as cowdung, starch and others were explored, success in terms of stove design could not be obtained. Most of the

results were extracted later from configurations involving sawdust tamped into place using two cylindrical PVC (polyvinyl chloride) tubes of a diameter equal to the port dimension desired. Port dimensions of 40–65 mm diameter were explored.

After the stove was loaded (usually to bulk densities of about 220–280 kg/m³ by hand ramming), lighting was performed in the classical way described earlier. In order to combust the volatiles released initially, a small burning wick was placed at the top edge of the central port. This ensured a flame, and therefore the possibility of smoke was eliminated. However, the top region of the fuel bed was open, and thus the flame spread at the top was producing a smoky flame. This being an unwanted propagation of flame, it was prevented by covering the top fuel surface with a thin layer of ash. The essential idea here is that, for every fresh start of the stove, some ash from a previous run could be used for this purpose. Thus, the problem of ignition was overcome through the combination of providing a pilot flame at the top region and covering the top fuel surface with ash. The duration of the ignition period depended on the geometric dimensions of the stove. To evaluate it, several configurations were tried.

Table 1 gives details of the various configurations tried, and the observations. The port diameters on the horizontal and vertical portions were fixed at 40 mm. The stoves were arranged to have the horizontal leg partly covered, to permit the evaluation of the influence of the exposed portion. The dimension of the exposed portion is a . Larger values of a lead to a longer start-up time, implying the production of more smoke and the need for more time to stabilise. As a is reduced to 20 or 30 mm, the time required for ignition is reduced substantially, to about 2 min. The cause of this behaviour is believed to be the fact that air entering the stove at the bottom is consumed in the lower region. As a result, the upper part of the vertical section receives heat from the flue gases, but little oxygen. Thus the sawdust pyrolyses and leads to the generation of unburnt gases, resulting in smoke. As the horizontal section is reduced, more oxygen is made available in the upper regions of the vertical section. These issues become relevant if, at a given power level, the burn time required is very large. In the case of a 40 mm-diameter port, there would be no problem up to a burn time of 5 h, or a web thickness of 120 mm. As the height is increased, it appears that the upper sections tend to glow more slowly than the lower sections. Thus, a height of 210–230 mm seems almost optimal for a stove with a port diameter of 40 mm. This implies that $h/d \sim 5.3$ – 5.7 . Once the dimensions were optimized, it was found that sprinkling a small amount of kerosene and igniting it was adequate for an early stabilisation of the flame. A stove with a 40 mm port diameter and an $h/d \sim 5.5$, with a 150 mm outer diameter, leads to an average power level of about 2.0 kW. Reduction of the h/d to very low values was found to lead to unsteady and fluctuating flames, as mentioned in Table 1. Hence the h/d should be larger than about 4.5 or so.

During these experiments, it was observed that the extent of char residue which remained unburnt was significant, being as much as 30%. This does not mean that carbon conversion in the char was not occurring, resulting in white ash, but that the conversion process was so slow that the effective power available dropped to 20% of the initial power (in the present case, 2.5 kW). It was found that the outer metal wall temperature reached as much as 600 K. The heat losses could be inferred to be significant, and therefore insulation of the stove body was conceived as a means of raising the wall temperature, and hence the reactivity of the char

Table 1. Ignition time reduction with variation in h/a : $d_p = 40$ mm and $d_o = 150$ mm

Sl. No.	Horizontal arm mm	Height h mm	h/a	Smoking time min	Time required for ignition min	Remarks
1	135	185	1.37	20	20	
2	135	135	1.0	20	10	
3	95	185	1.95	0	3	steady state in 5 min
4	75	185	2.47	0	2	steady state in 5 min
5	65	185	2.85	0	2	steady state in 5 min
6	75	210	2.8	0	2	steady state in 5 min
7	75	165	2.2	0	2	steady state in 5 min
8	75	145	1.93	0	2	steady state in 5 min, but flame is unsteady

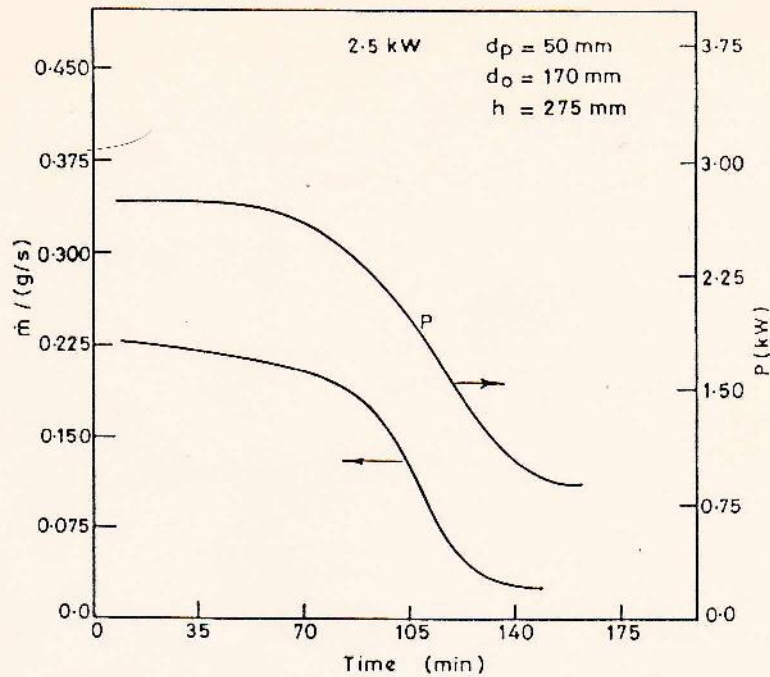

Figure 2. Variation of fuel mass loss rate and estimated power with time in a typical operation

close to the wall. The insulation of the stove reduced the extent of unburnt char to about 15%, compared with 28% in an uninsulated stove. A typical plot of the fuel mass loss rate and the power from the stove are presented in Figure 2. In the first portion it can be seen that the fuel loss rate is constant. During this period, volatiles would be released. The calorific value of these gases are estimated from the percentage of volatiles. This value works out to 12–14 MJ/kg. During the second phase, when the char is being consumed, the power starts dropping. The weight loss rate is much lower, owing to the char conversion rate. The power is estimated from the calorific value of the char at 28–30 MJ/kg. As is evident from Figure 2, the power level is about 0.8 kW over a long period, so much so that it may not transmit any useful heat to the system. During this period, a higher power level could be achieved by introducing woody biomass through the air inlet at the bottom.

Further studies were conducted by setting the height at 220 mm, but varying the port diameters from 40 to 60 mm in the horizontal and vertical sections. The results are set out in Table 2. As both the dimensions (diameters) are increased, one expects an increase in the power level. This should be kept in mind when examining Table 2. An increase in the vertical section diameter tends to prolong the yellow flame duration, indicating that not enough air is being pumped by free convection, whereas reducing the diameter reduces the power level. Equal values for the diameters of the two sections seem to give better performance in terms of the flame temperature, the nature of the flame, and the stability of the flame. The lack of stability implies that the flame would be extinguished and would reignite sporadically. For 220 mm height, a port diameter of 40 mm seems to give the best overall performance. It is concluded from Table 2 that an h/d of about 5.5 and equal diameters for the vertical and horizontal ports are to be chosen for good performance. The results of experiments with varying heights of stove (implying the height of the fuel bed) and other dimensions, along with the power, are presented in Table 3. The power was measured by conducting the experiments, placing the stove on a balance, and obtaining the loss of weight with time.

As can be seen, the stove power averages 2.0 kW for a 40 mm port, 2.5–2.7 kW for a 50 mm port, and 4.5–5.5 kW for a 60 mm port. The $h/d \sim 4.5$ –6.0. The measured peak temperature of the flame goes up to about 1300 K. The average flame temperature is around 1200 K.

Table 2. Quality of flame as a function of port dimensions: outer diameter of stove = 150 mm and height = 220 mm

Sl. No.	Diameter of air inlet mm	Port diameter mm	Smoke condition	Soot	Flame temperature K	Colour of flame for first 30 min	Remarks
1	40	40	no smoke	no soot	1300	bluish	
2	40	50	no smoke		1250 1300	bluish yellow	
3	40	60	no smoke	no soot		yellow	
4	50	40	no smoke	no soot		bluish yellow	unstable flame
5	50	50	no smoke	no soot	1250 1300	bluish yellow	
6	50	60	no smoke	no soot		yellow	
7	60	40	no smoke	no soot	1300	bluish yellow	Flame only for 20 min
8	60	50	no smoke	no soot	1250	bluish yellow	unstable flame
9	60	60	no smoke	no soot	1250 1300	bluish yellow	unstable flame

Table 3. Quality of flame as a function of height and port dimensions: outer diameter of stove = 150 mm

Sl. No.	Height of fuel h mm	Air inlet diameter d_{ph} mm	Port diameter ' d_p ' mm	h/d_p	Average Power for first 30 min (kW)	Description of flame
1	180	40	40	4.5	2.4	orange-yellow flame
2	200	40	40	5.0	2.3	bluish flame, steady state quickly obtained
3	220	40	40	5.5	2.4	bluish flame
4	240	40	40	6.0	2.4	yellow flame, occasionally sooty
5	180	40	46	3.9	2.6	yellow flame, occasionally sooty
6	200	40	46	4.3	2.6	orange-yellow flame
7	220	40	46	4.8	2.6	yellow sooty flame
8	240	40	46	5.2	2.8	yellow sooty flame
9	195	50	50	3.9	2.6	bluish-yellow flame
10	205	50	50	4.1	2.7	bluish-yellow flame
11	225	50	50	4.5	2.8	yellow-flame, occasionally sooty
12	245	50	50	4.9	3.7	yellow sooty flame
13	330	58	63	5.3	5.5	yellow sooty flame
14	290	58	63	4.6	4.5	bluish-yellow flame

COMBUSTION BEHAVIOUR

The combustion behaviour of this stove is different from those of classical wood stoves. The geometry is more regular and well defined. The air flow into the port occurs because of free convection, which is due to the hot fuel surface and the hot gases. The volatiles that are released by the fuel enter the duct near the 'wall', and burn with the air in the thin layer near the wall, i.e. the boundary layer. The similarity of this combustion process with that occurring in a hybrid rocket motor is striking. Whereas, in the latter, the process is dominated by forced convection, in the stove it is dominated by free convection. The ignition period consists of the release of volatiles from the surface of the porous fuel block, causing charring of the surface.

Subsequently, the thermal profile moves inside the porous fuel block, releasing volatiles continuously. The air that is drawn into the port diffuses into the porous fuel media, and causes part of the heat release to permit continuous propagation. The role played by the horizontal duct in this phenomenon is critical. For instance, if a hollow cylindrical block without the horizontal port were ignited at the bottom, it would turn out to be highly unsteady, and the flame would be extinguished unless a wick, like the heat source, is kept at the bottom. This implies that, for a successful continuous combustion process to occur, the bottom region must be kept hot and as near adiabatic as can be achieved. In fact it is observed that, under operating conditions, the bottom region, particularly the one facing the supply of air, is very hot, including the surface, both being close to 1000 K. Such benign conditions for the stabilisation of the flame cannot be obtained if the horizontal duct is absent.

One of the interesting features in a hybrid rocket motor which uses a fuel block with a central port, and in which combustion with the oxygen stream in the port occurs close to the surface, i.e. much as in the present stove, is that the stream is stratified. There are regions which are fuel and oxidiser rich. To obtain better performance, it is seen to be necessary that the two streams be mixed [4].

In the present case, too, one may expect a similar stratification. In order to cause better mixing of the gases, a perforated flame holder is placed above the central port. During the operation of the stove, it is found that the flame holder becomes red hot, and some recirculation of gases takes place, and on occasions, yellowish tongues turn orange.

During these experiments it was observed that there were cracks in the fuel block at several regions. Fuel vapours were seen oozing out of these cracks. Since the burning area would be enhanced by these cracks, some of which were found to be as deep as the web itself, one could expect the outer diameter to have an influence on the power level at other fixed dimensions.

When the stove was extinguished, observation of a horizontal section of the fuel block showed a nearly circular boundary separating the virgin fuel from the pyrolysed mass. It was inferred that, during the first phase, the pyrolysis of the fuel was providing the vapours for combustion, and during the second phase, when the pyrolysis was complete, the char would oxidise and provide heat. This feature is consistent with the high power level in the first phase and a decaying low power level in the second phase. If the duration of the peak power level is considered as the operating time of the system, then one can determine the rate of movement of the pyrolysis front to fix the outer boundary. A technique was devised to determine this rate. It is based on the fact that pyrolysis takes place at around 620 ± 40 K in wood [5]. By determining the time for the propagation of an isotherm at, say, 620 K, one would obtain the rate of movement of the pyrolysis front. To obtain this, experiments were conducted with a number of thermocouples fixed at several radial locations inside the fuel block, and the variation of the local temperature was obtained during a run on the stove. A typical plot is shown in Figure 3. By the considerations indicated above, the time taken for an isotherm of 623 K to propagate a distance of 32 mm is about 87 min, leading to an average propagation rate of 0.36 mm/min. Further experiments revealed that the average propagation rates decrease with the web thickness, and this result is described by

$$\dot{r} = 0.0094[(d_o - d_p)/2]^{-0.13} \text{ mm/s} \quad (1)$$

where the geometric dimensions are in millimetres, and \dot{r} is the propagation rate in millimetres per second. The relation is valid for $(d_o - d_p)$ between 50 and 500 mm. This covers a wide range of operational times upto 25 h (continuous).

USE OF WOODY BIOMASS IN THE STOVE

The function of the packed powder is to permit the release of volatiles inside, and permit a certain amount of premixing before combustion occurs in the cylindrical vertical port. We explored the possibility of replacing part of the material with leaves, tender sticks, dried tiny plants and wood pieces. Experiments indicated that the stove would perform satisfactorily, apart from the quality of the flame. The flame would tend to be yellowish whenever a woody biomass was seen to be discharging the volatiles.

DEPENDENCE OF POWER LEVEL ON OUTER DIAMETER

Experiments were conducted for outer diameters of 150, 250 and 500 mm, with port (or core) diameters of 40, 50, 63 mm. In all cases, the height was set at $5.5 d_p$. The results of the ratio of the power at any instant to the initial power level are plotted as a function of time for the several cases considered in Figures 4a and b, for port diameters of 40 and 63 mm. Barring initial transients, it can be seen that the mass flow rate is nearly constant until it drops sharply. The results of the fuel mass loss rate \dot{m}_f with varying port and outer diameters

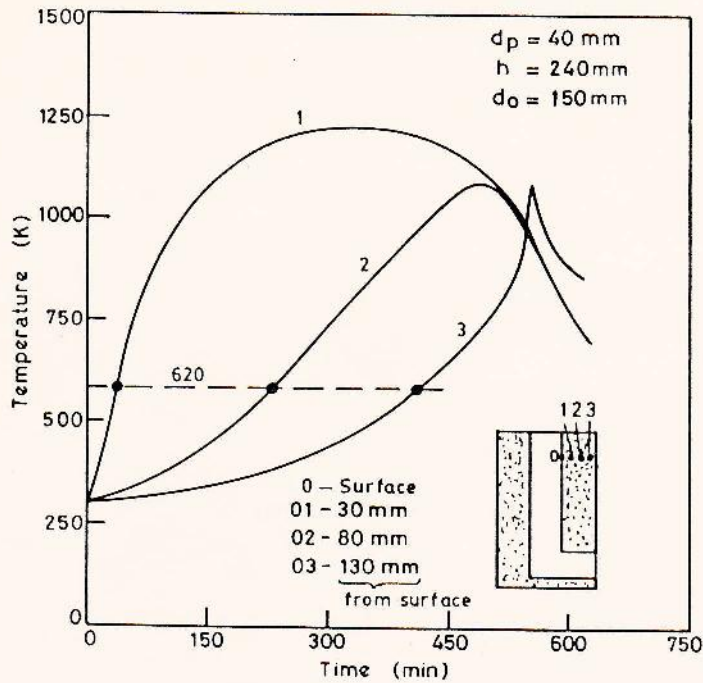

Figure 3. Variation of local temperature at three locations inside fuel block with time for stove in operation

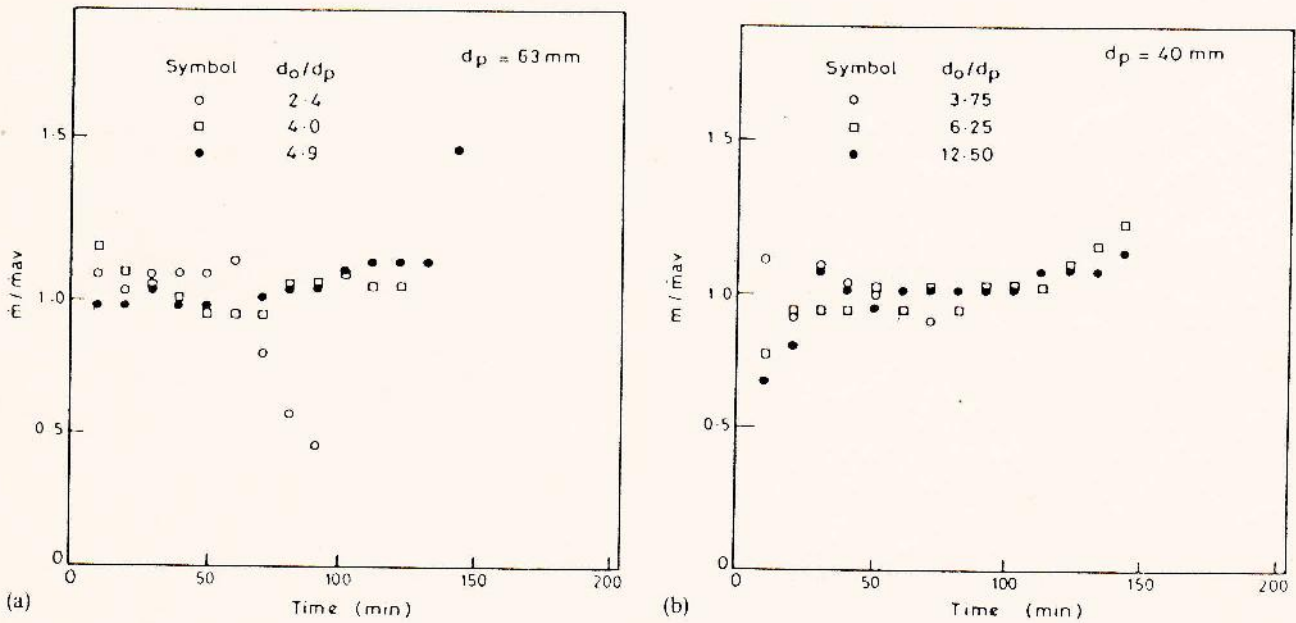

Figure 4. Variation of ratio of fuel mass loss rate to initial mass loss rate with time during operation of stove

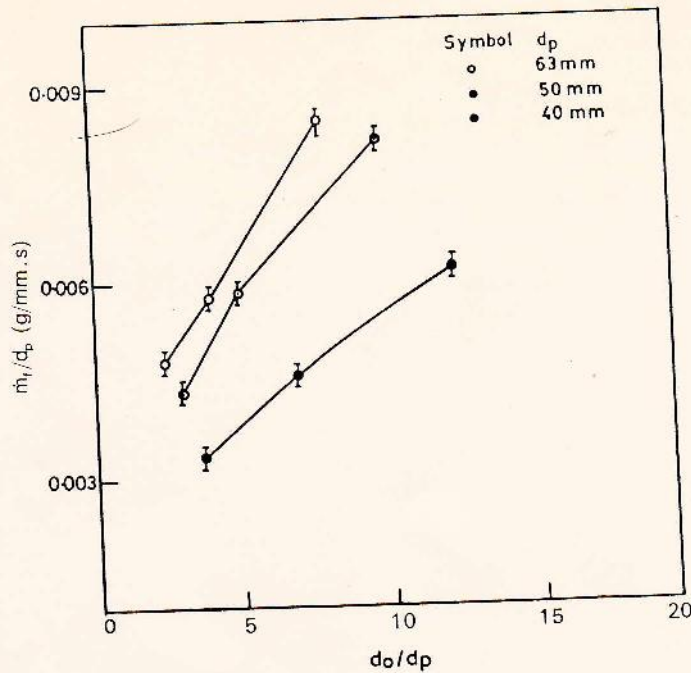

Figure 5. Plot of \dot{m}_f/d_p against d_0/d_p

are plotted in Figure 5 as \dot{m}_f/d_p against d_0/d_p . These results can be curve-fitted into an equation as follows:

$$\dot{m}_f = 6.1 \times 10^{-5} d_p^{1.75} d_0^{0.5} \quad (2)$$

where \dot{m}_f is the fuel weight loss rate in kg/hr, d_p and d_0 in mm. It is taken that h/d_p is around 5.5. The power level is obtained by multiplying \dot{m}_f by the calorific value (14 MJ/kg).

EXTENSION OF BURN TIME BY CHANGE OF POWER LEVEL

As discussed earlier, the power level remains high as long as volatiles are being released, and then drops slowly as in Figure 2. It can be seen that the power is maintained at about 2.5 kW or more for about an hour of burning, and from then onwards the power falls slowly. Suppose it was intended to raise the power level, say, 70 min after the start. All that needs to be done is to introduce a few wood sticks at the air entry zone. The additional combustion provides the needed boost in power. In this sense, the powdery biomass stove acts, in addition, as a woody biomass stove.

MEASUREMENT OF AIR FLOW

After the parameters of the stove were set, it was thought to be important to make measurements of the air flow rate. Since it is difficult to establish a reference for determining the flow which simulates natural convection conditions, a qualitative measure of the flame height and nature were used to assess the flow rate under natural convection conditions. The outflow from a blower passing through a valve and a calibrated venturi flow meter was connected to the bottom horizontal leg of the stove and sealed. The flow rate was set so that the flame looked just as it did for free convection. A further test was performed by withdrawing the air supply and allowing natural convection to establish the flame. The similarity of the flame before and after the air supply was established was taken as an indication of whether the air supply from the blower was correct.

These experiments were supplemented by nearly identical ones in which the fuel consumption rate (or the power of the stove) was measured. Table 4 summarizes the results of several tests. Measured values of air to fuel ratio (A/F) are in the range of 4.7–5.8. The stoichiometric A/F for sawdust is around 6.5–6.7. Thus it appears that the air pumped by the system is inadequate even for stoichiometric conditions, despite the fact that the combustion was complete with an ambient CO level in the range of 10–20 parts per million. This was somewhat surprising, and a re-examination of the experimental conditions confirmed the above results. This is true because, during the initial period of the stove operation, only the volatiles are combusting, with very little char combustion. In fact, it appeared that a slight change from the nominal conditions, both above and below, showed substantial changes in the flame structure compared with what would be expected under natural convection conditions. This confirmed the result that the operation is close to the stoichiometric, and not fuel rich.

The fact that the air to fuel ratio of the operation is slightly fuel rich sometimes means that additional air should be supplied beyond the height of the fuel in order to completely combust the fuel. This air is taken by the system from the ambient air in the top region of the stove through a perforated shield.

MEASUREMENT OF EFFICIENCY

The efficiency of the stove is the ratio of the heat delivered to the energy input from the fuel. This is relatively easy to measure in the case of a woody biomass stove, but poses difficulties in the present case. Typically, what is used to absorb the heat is a flat-bottomed aluminium vessel with an amount of water depending on the power level. 5 litres of water for 2.5 kW and 10 litres for 4 kW are typical.

One way of assessing the efficiency is to measure the temperature rise rate of the water, and so obtain the heat extracted, and divide it by the product of the measured fuel consumption rate and the heat of combustion. It must be understood that the primary heat release agent is the volatiles from the sawdust. This method does not give a proper assessment of the overall efficiency, because the amount of char left unburnt has to be accounted for. Therefore what is done is repeated extraction of the heat until the extraction becomes insignificant. Measurements of efficiency as outlined above indicated values of 32–36%, depending on the size of the vessel chosen. Larger-sized vessels (> 300 mm diameter) give higher values. These values are smaller than would be obtained on wood stoves, which can reach 45% [3] at similar power levels and operating conditions. The efficiency based on the heating rate in the early period is much higher, at 38–42%. Thus the reduction in efficiency is caused by the inefficient heat extraction from the char. It has been found that the air vent at the bottom should be partly closed during the tail-off period to reduce the amount of air taken in, because the carbon conversion rate is lower, to maintain a better A/F and a higher temperature. But even this operation is not conducive to heat transfer beyond a certain stage, where the power level will be very low, in fact comparable to the heat losses in the system. Despite these features, the attention required to carry on with the cooking task is much smaller than for a woody biomass stove, since no tending need be done if the power and burn time are matched approximately to the requirements. For instance, cooking for 5–6 people needs one class of design, and cooking for 10–15 people needs another.

Table 4. Variation of A/F with variations in stove dimensions

Sl. No.	Height of stove h mm	Port diameter d_p mm	Air flow rate A gm/min	Fuel burning rate F gm/min	A/F
1	200	45	56.4	12.0	4.7
2	220	50	80.4	16.0	5.2
3	300	63	115.2	20.0	5.8

DESIGN OF STOVE

The design of the stove depends on the power level $P(\text{kW})$ and the burn duration t_b , required. The burn time is related to the geometry through the average rate of movement of the pyrolysis front, as given by

$$(d_0 - d_p)/2 = t_b \bar{r} \tag{3}$$

Using equation (1), one can obtain

$$d_0 - d_p = 45t_b^{0.885} \tag{4}$$

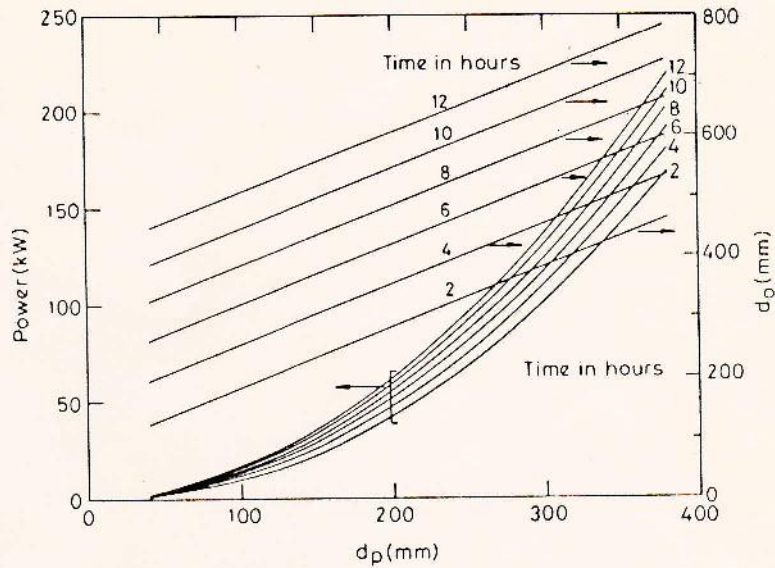

Figure 6. Single-port stove design chart for various power levels and burn time

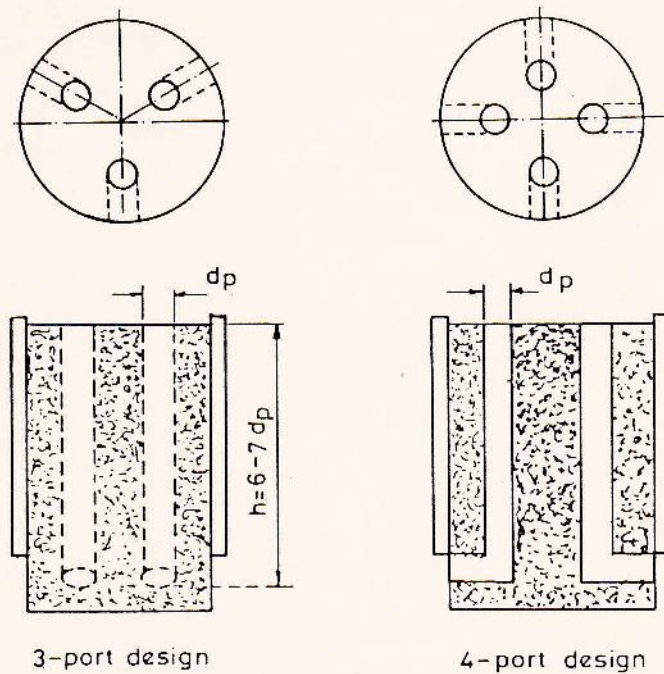

Figure 7. Multiport configurations for stove design

where the geometric dimensions are in millimetres and t_b , and the burn time, is in hours.

The power level is obtained from equation (2) and the calorific value of the pyrolysis gases as

$$P = 2.4 \times 10^{-4} d_p^{1.75} d_o^{0.5} \quad (5)$$

Equations (4) and (5) are to be solved together for a given power and burn time to obtain d_p and d_o in millimetres. The result, along with $h/d_p = 5.5$, gives all the design parameters of the stove. However, the use of a lower $h/d_p \sim 4.0$ at large d_p (~ 150 mm) does produce reasonable results. Figure 6 gives the design chart which can be used to obtain the dimensions of the stove needed for a given power level and burn time. One can interpolate between the results of the curves suitably to estimate the parameters.

MULTI-PORT DESIGNS

The design of the stove so far presented corresponds to a single central port. There is no reason why one cannot use multiports in the design of the stove. Typical configurations are shown in Figure 7. Several of these have been tested, and one can obtain different power-level/burn-time combinations by using multiport configurations. The precise design of such stoves can be undertaken by adjusting the initial burn area, which is the total perimeter of the open area multiplied by the height and the web available for the burn. An advantage of this design is that a higher power level is obtained for a given stove volume, without compromising on the combustion quality. The design charts for these designs are yet to be evolved.

CONCLUDING REMARKS

This paper has addressed the design and performance of stoves meant primarily for powdery biomass. It has been found that the stove can be operated with about 50% woody biomass, which may consist of dried plants, wood sticks and such other nonpowdery biomass, provided that a minimum of 50% of powdery biomass is used. It is indicated that enhancement of burn time with high power can be achieved by using woody biomass during the later period. Experiments and analysis have resulted in equations that can be used to design the stove for a given power and burn time. Multiport variants of the single-port design are also indicated as possibilities.

The results presented here are the outcome of the projects on stoves, administered and financed by the Karnataka State Council for Science and Technology, Bangalore, to whom the authors are grateful for the support provided.

REFERENCES

- 1 Kishore, V. V. N. (1990). 'Design, fabrication, testing and field demonstration of biomass gasifier systems for irrigation pumping', Final report to Department of Nonconventional Energy Sources, New Delhi.
- 2 Kristoferson, L. A. and Bokalders, V. (1986) *Renewable energy technologies and their applications in developing countries*. Study by Beijer Institute, Royal Swedish Academy of Sciences, Pergamon Press, Oxford.
- 3 Mukunda, H. S., Shrinivasa, U. and Dasappa, S. (1988) 'Portable single pan wood stoves of high efficiency for domestic use', *Sadhana, JIA Sec.*, **13**, part 4, 237-270.
- 4 Mukunda, H. S., Jain, V. K. and Paul, P. J. (1979). 'A review of hybrid rockets: Present status and future potential', *Proc. Indian Acad. Sci.*, **C 2**, 215-242.
- 5 Roberts, A. F. (1971). 'The heat of reaction during the pyrolysis of wood', *Combustion and Flame*, **17**, 79-86.